

COOLEGE™

COOLEGE TILE INTERIOR/TUNABLE WHITE QUICK START GUIDE

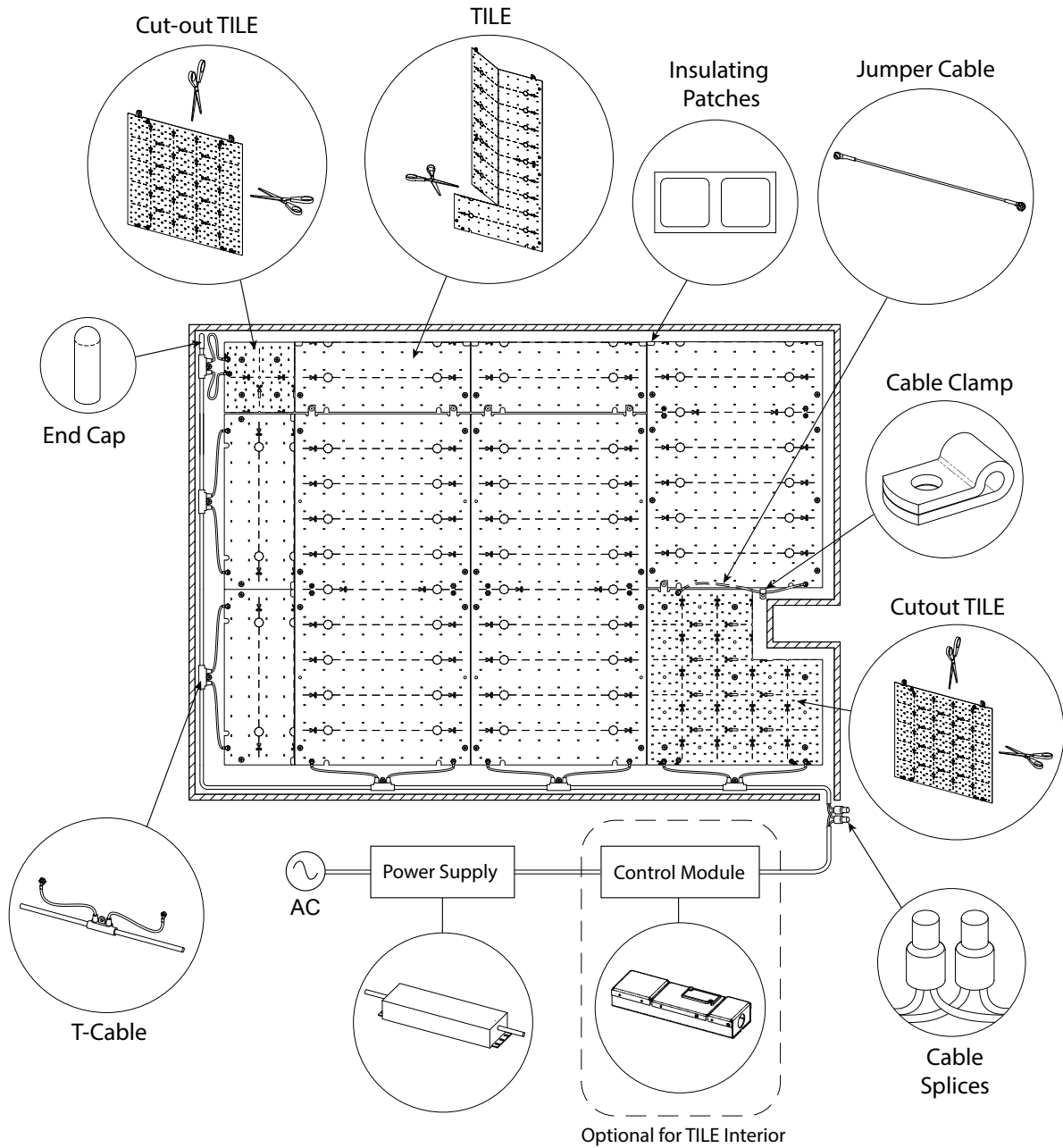

For detailed instructions, please refer to:

- EXT-0066: Cooledge TILE Interior/Tunable White Installation Guide
- EXT-0071: Cooledge Control Module User Guide



Caution: Observe precautions for handling electrostatically sensitive devices.



In Canada, TILE Interior must be installed within an enclosure

RoHS



5 Year Limited Warranty: Parts and workmanship

Cooledge Lighting Inc.
110-13551 Commerce Parkway
Richmond, BC V6V 2L1 Canada

O +1 604 273 2665
F +1 604 273 2660
T +1 844 455 4448
W cooledgeighting.com

Cooledge Lighting reserves the right to change materials or modify the design of its product without notification as part of the company's continuing product improvement program.

1 INSTALL TILE

NOTE: Mounting surface must be non-conductive (eg. drywall, plywood, etc)

Snap together to connect light sheets

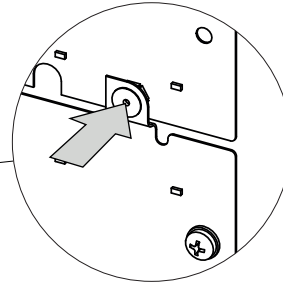
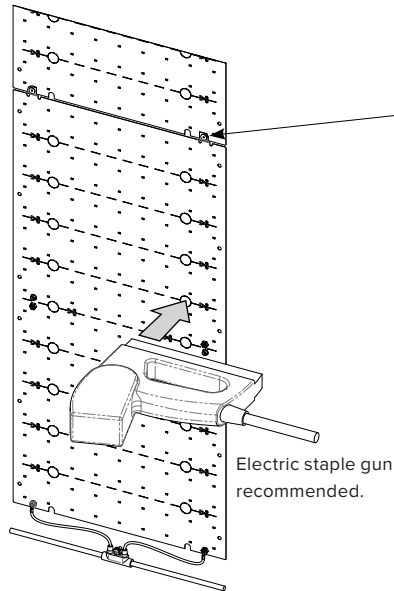
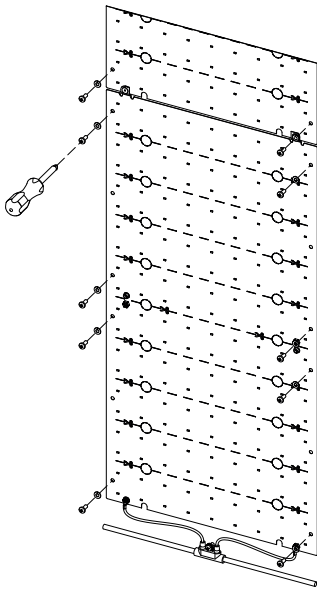

Install with screws and plastic washers (M4 or #8 screw)

or Staple inside circles (Max recommended staple size = 1/2" or 12mm)

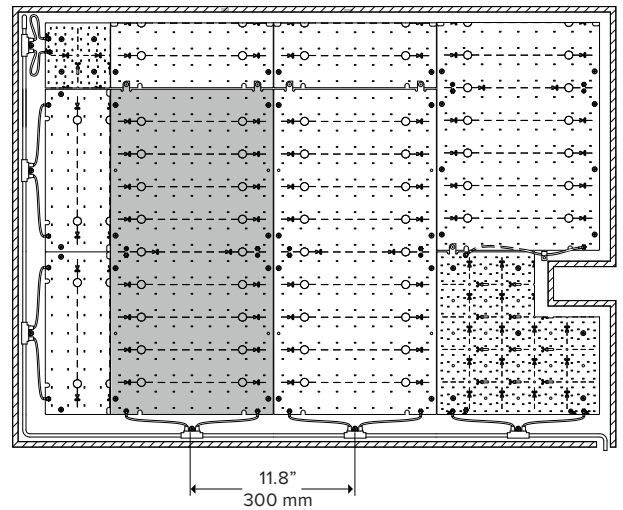

2 CUT TILES

Install insulation patches at each corner of the cut edge

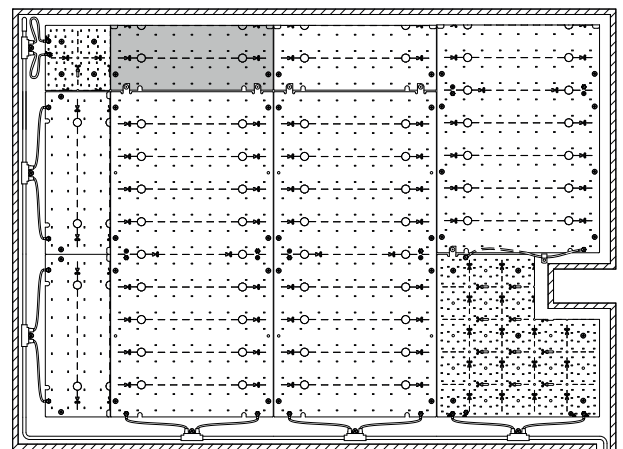
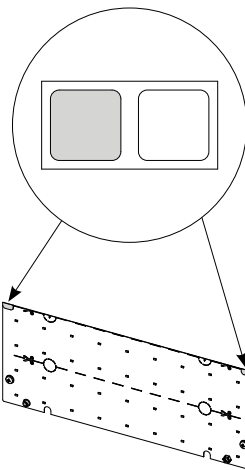
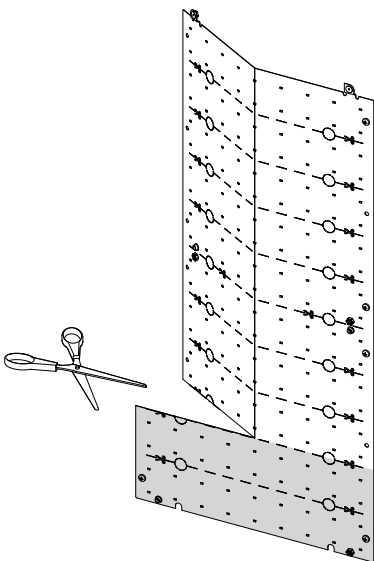

3 INSTALL CUT-OUT TILE IN CORNER

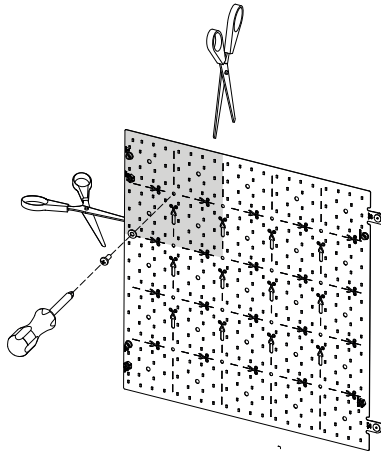

Install with screws and plastic washers.
Do not use staples on the Cut-out TILE.

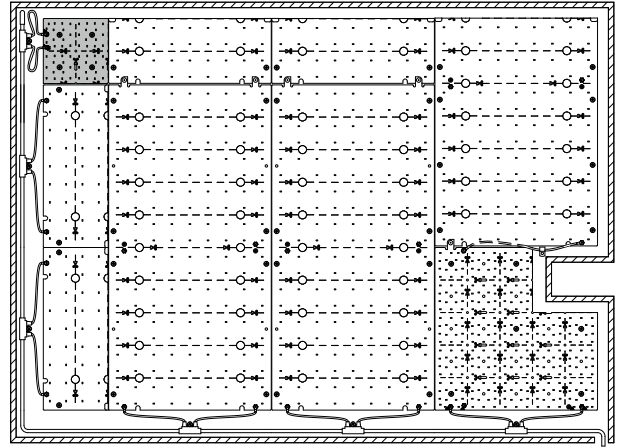

4 INSTALL CUT-OUT TILE(S)

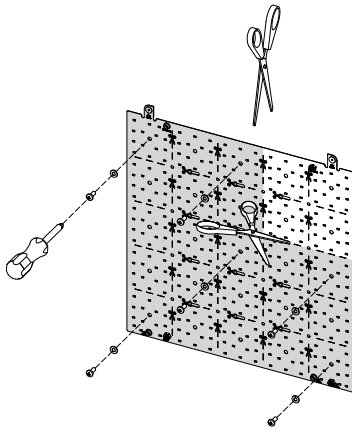

Install with screws and plastic washers.
Do not use staples on the Cut-out TILE.

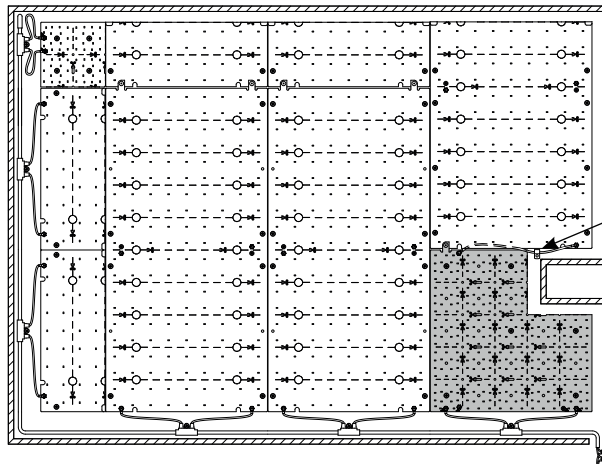

5 INSTALL T-CABLE AND CUT TO SIZE

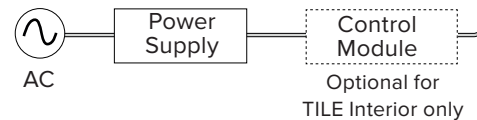
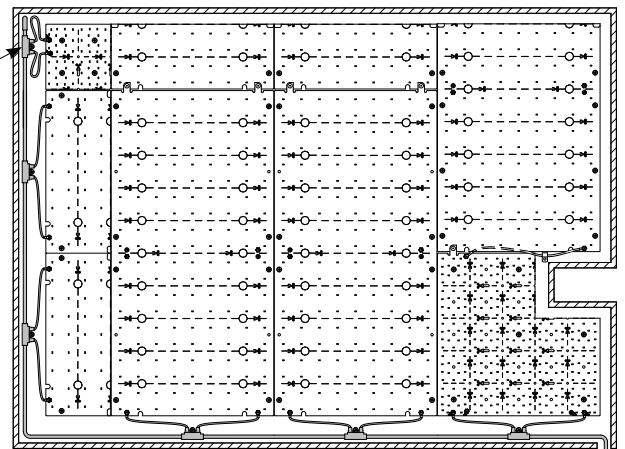
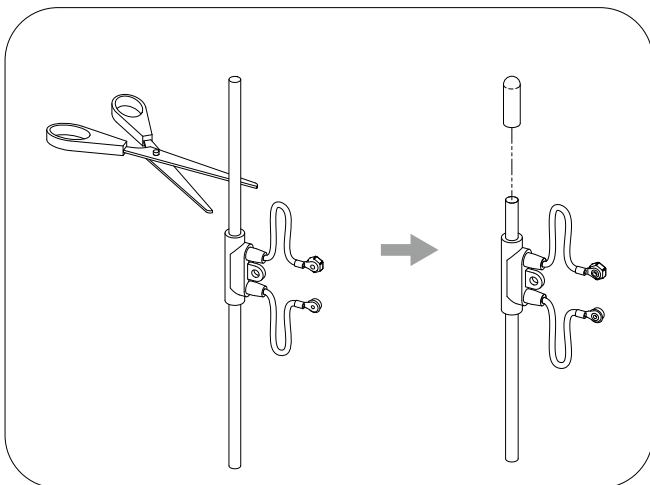

DO NOT BEND SHEETS SHARPLY AROUND CORNERS

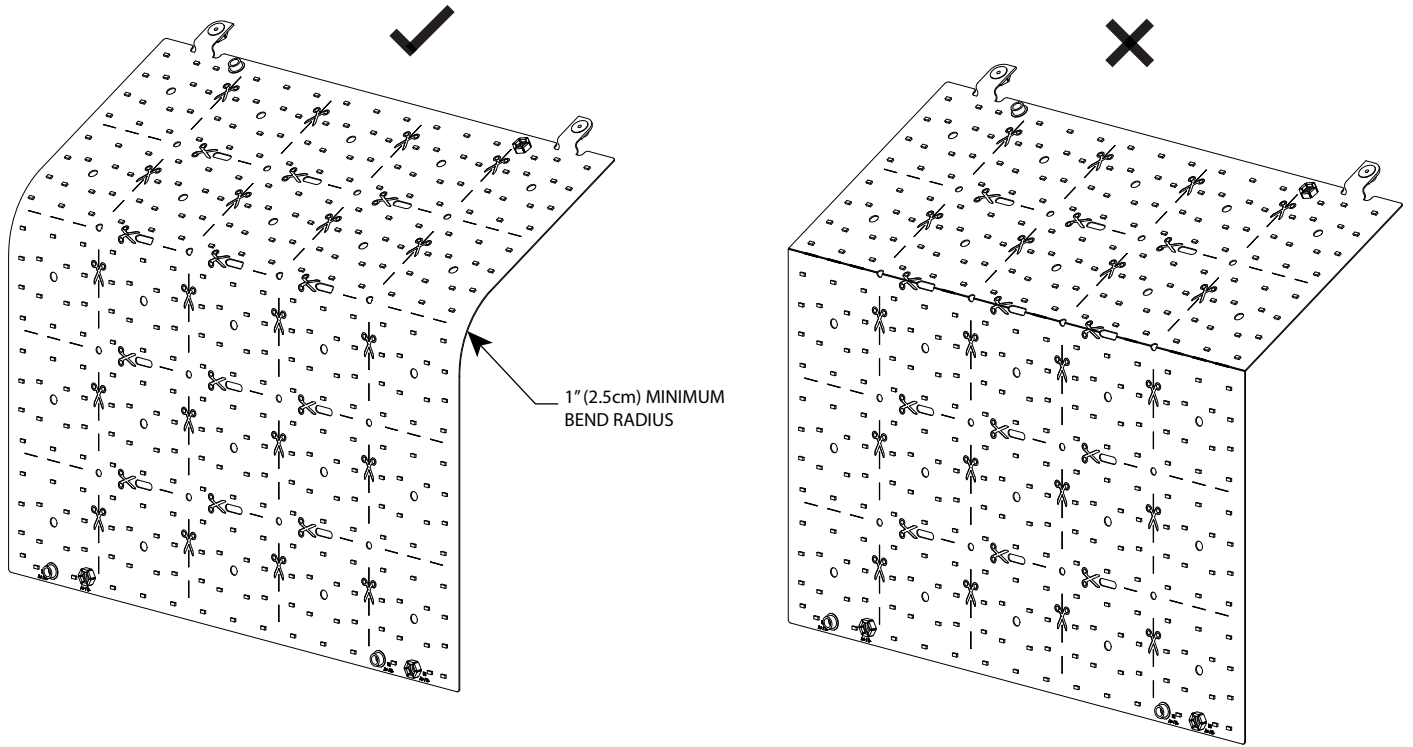

CUT-OUT TILE- ACCEPTABLE INTERNAL CUT-OUT CONFIGURATIONS (EXAMPLES)

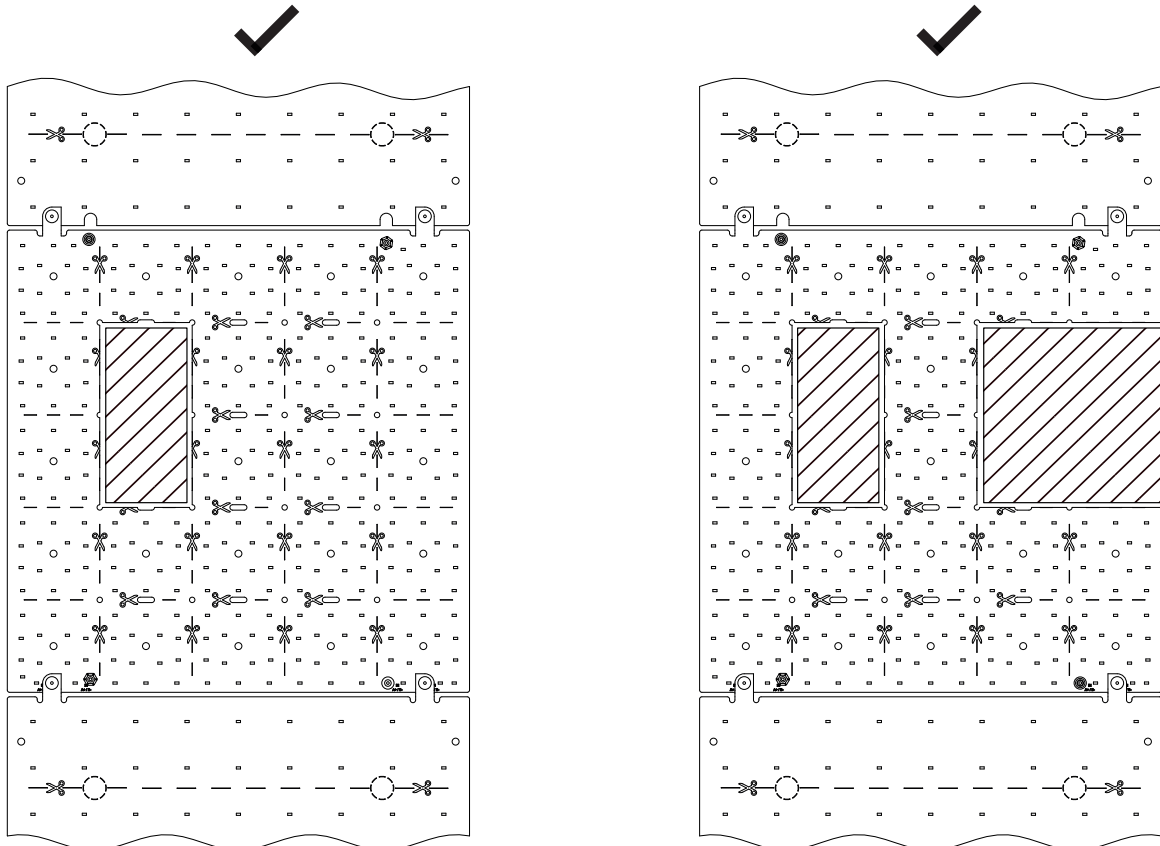

CUT-OUT TILE - ACCEPTABLE CORNER CUT-OUT CONFIGURATIONS (EXAMPLES)

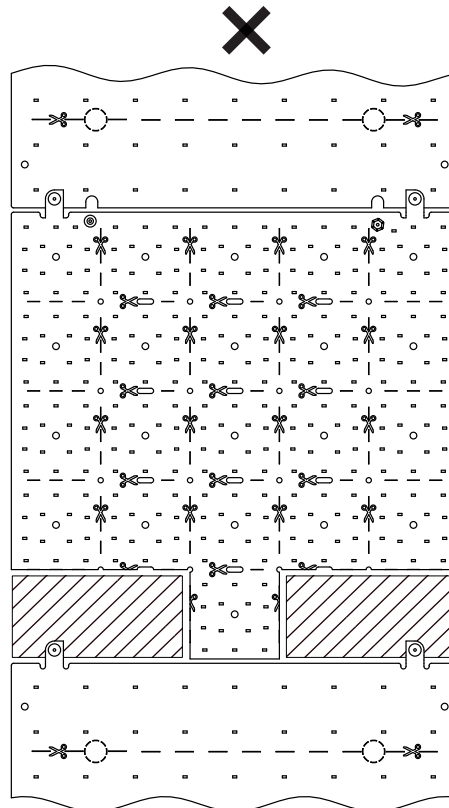
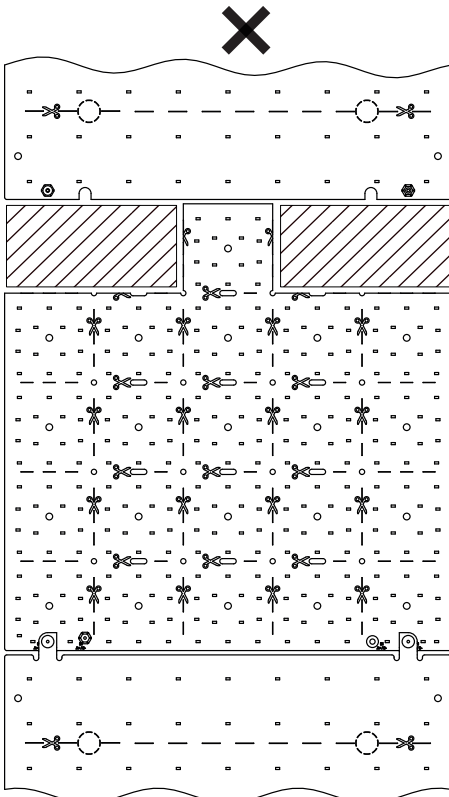
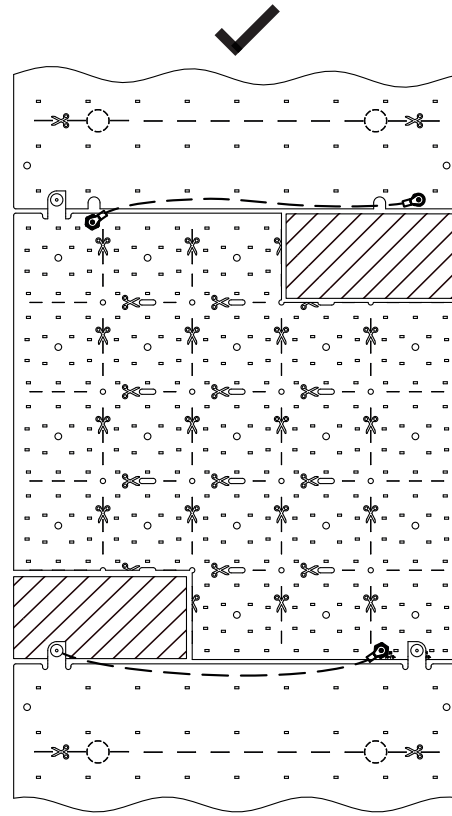
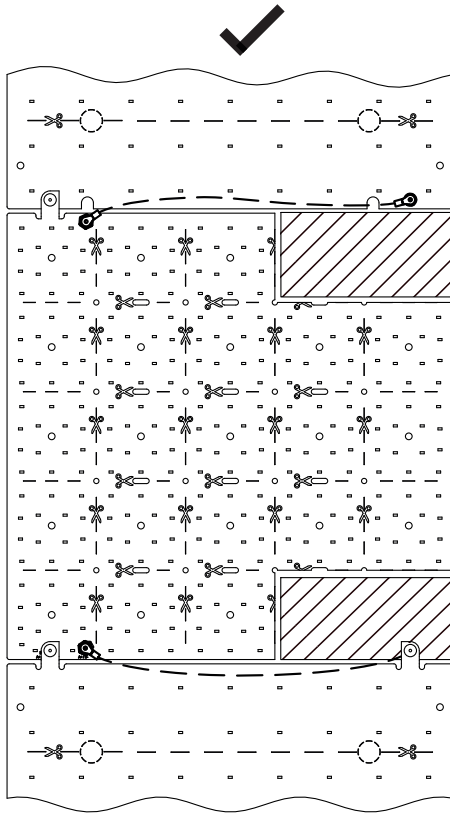

STARTER KIT CONTENTS

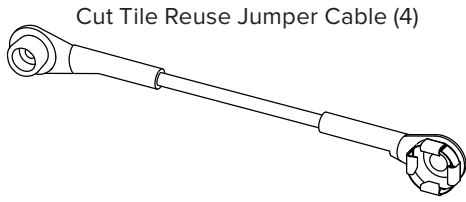

Cut Tile Reuse Jumper Cable (4)

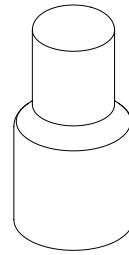

Splice Connector (4)

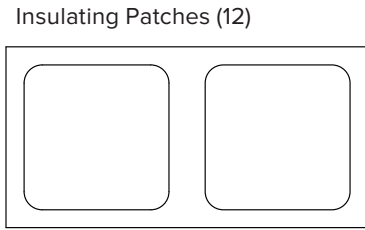

Insulating Patches (12)



T-Cable End Cap (4)



Quick
Start
Guide

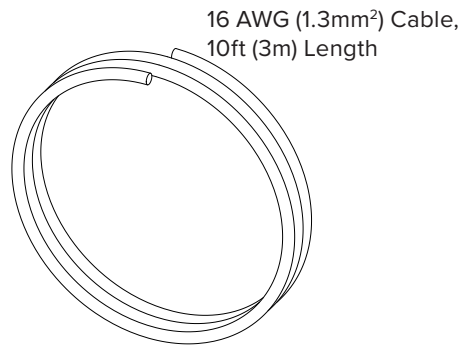

16 AWG (1.3mm²) Cable,
10ft (3m) Length

CUT-OUT KIT CONTENTS

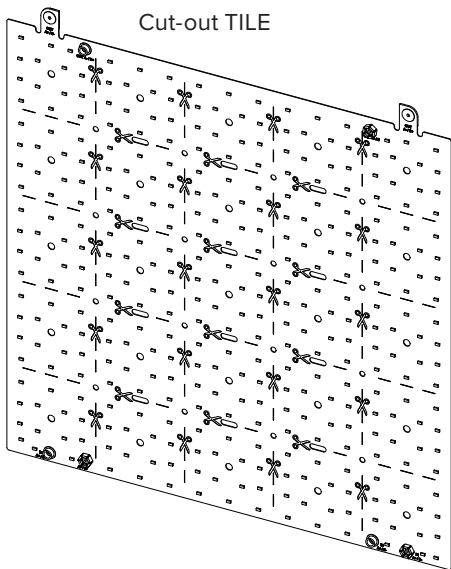

Cut-out TILE

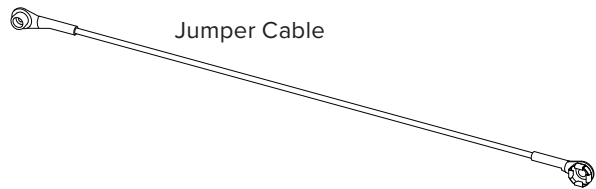

Jumper Cable

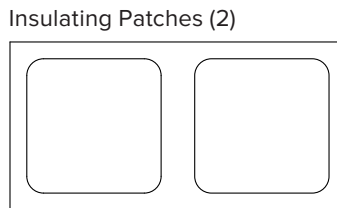

Insulating Patches (2)

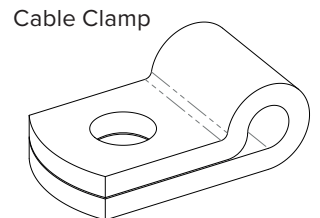

Cable Clamp